

Inter-regional comparison of land-use effects on stream metabolism

MELODY J. BERNOT*, DANIEL J. SOBOTA^{†,‡}, ROBERT O. HALL, JR[§], PATRICK J. MULHOLLAND[¶], WALTER K. DODDS^{**}, JACKSON R. WEBSTER^{††}, JENNIFER L. TANK^{‡‡}, LINDA R. ASHKENAS[†], LEE W. COOPER^{§§}, CLIFFORD N. DAHM^{¶¶}, STANLEY V. GREGORY[†], NANCY B. GRIMM^{***}, STEPHEN K. HAMILTON^{†††}, SHERRI L. JOHNSON^{‡‡‡}, WILLIAM H. MCDOWELL^{§§§}, JUDITH L. MEYER^{¶¶¶}, BRUCE PETERSON^{****}, GEOFFREY C. POOLE^{††††}, H. MAURICE VALETT^{††}, CLAY ARANGO^{‡‡}, JAKE J. BEAULIEU^{‡‡}, AMY J. BURGIN^{†††}, CHELSEA CRENSHAW^{¶¶}, ASHLEY M. HELTON^{¶¶¶}, LAURA JOHNSON^{‡‡}, JEFF MERRIAM^{§§§}, B. R. NIEDERLEHNER^{††}, JONATHAN M. O'BRIEN^{†††}, JODY D. POTTER^{§§§}, RICHARD W. SHEIBLEY^{****,¶¶,‡‡‡}, SUZANNE M. THOMAS^{****} AND KYM WILSON^{**}

*Department of Biology, Ball State University, Muncie, IN 47306, U.S.A.

†Department of Fisheries and Wildlife, Oregon State University, Corvallis, OR 97331, U.S.A.

‡School of Earth and Environmental Sciences, Washington State University-Vancouver Campus, Vancouver, WA 98686, U.S.A.

§Department of Zoology and Physiology, University of Wyoming, Laramie, WY 82071, U.S.A.

¶Environmental Sciences Division, Oak Ridge National Laboratory, Oak Ridge, TN 37831, U.S.A.

**Division of Biology, Kansas State University, Manhattan, KS 66506, U.S.A.

††Department of Biological Sciences, Virginia Tech, Blacksburg, VA 24061, U.S.A.

‡‡Department of Biological Sciences, University of Notre Dame, Notre Dame, IN 46556, U.S.A.

§§Chesapeake Biological Laboratory, University of Maryland Center for Environmental Science, Solomons, MD, U.S.A.

¶¶Department of Biology, University of New Mexico, Albuquerque, NM 87131, U.S.A.

***School of Life Sciences, Arizona State University, Tempe, AZ 85287, U.S.A.

†††Kellogg Biological Station, Michigan State University, Hickory Corners, MI 49060, U.S.A.

‡‡‡Pacific NW Research Station, US Forest Service, Corvallis, OR 97331, U.S.A.

§§§Department of Natural Resources and the Environment, University of New Hampshire, Durham, NH 03824, U.S.A.

¶¶¶Institute of Ecology, University of Georgia, Athens, GA 30602, U.S.A.

****Ecosystems Center, Marine Biological Laboratory, Woods Hole, MA 02543, U.S.A.

††††Department of Land Resources and Environmental Sciences, Montana State University, Bozeman, MT 59717, U.S.A.

‡‡‡‡USGS Washington Water Science Center, Tacoma, WA 98402, U.S.A.

SUMMARY

1. Rates of whole-system metabolism (production and respiration) are fundamental indicators of ecosystem structure and function. Although first-order, proximal controls are well understood, assessments of the interactions between proximal controls and distal controls, such as land use and geographic region, are lacking. Thus, the influence of land use on stream metabolism across geographic regions is unknown. Further, there is limited understanding of how land use may alter variability in ecosystem metabolism across regions.

2. Stream metabolism was measured in nine streams in each of eight regions ($n = 72$) across the United States and Puerto Rico. In each region, three streams were selected from a range of three land uses: agriculturally influenced, urban-influenced, and reference streams. Stream metabolism was estimated from diel changes in dissolved oxygen concentrations in each stream reach with correction for reaeration and groundwater input.

Correspondence: Melody J. Bernot, Department of Biology, Ball State University, Muncie, IN 47306, U.S.A.

E-mail: mjbernot@bsu.edu

3. Gross primary production (GPP) was highest in regions with little riparian vegetation (sagebrush steppe in Wyoming, desert shrub in Arizona/New Mexico) and lowest in forested regions (North Carolina, Oregon). In contrast, ecosystem respiration (ER) varied both within and among regions. Reference streams had significantly lower rates of GPP than urban or agriculturally influenced streams.
4. GPP was positively correlated with photosynthetically active radiation and autotrophic biomass. Multiple regression models compared using Akaike's information criterion (AIC) indicated GPP increased with water column ammonium and the fraction of the catchment in urban and reference land-use categories. Multiple regression models also identified velocity, temperature, nitrate, ammonium, dissolved organic carbon, GPP, coarse benthic organic matter, fine benthic organic matter and the fraction of all land-use categories in the catchment as regulators of ER.
5. Structural equation modelling indicated significant distal as well as proximal control pathways including a direct effect of land-use on GPP as well as SRP, DIN, and PAR effects on GPP; GPP effects on autotrophic biomass, organic matter, and ER; and organic matter effects on ER.
6. Overall, consideration of the data separated by land-use categories showed reduced inter-regional variability in rates of metabolism, indicating that the influence of agricultural and urban land use can obscure regional differences in stream metabolism.

Keywords: ecosystem respiration, land use, metabolism, primary production, stream

Introduction

Stream ecosystem metabolism includes both gross primary production (GPP), which essentially represents photosynthesis by aquatic autotrophs, and ecosystem respiration (ER), which comprises organic matter breakdown by both autotrophs and heterotrophs. Thus, stream ecosystem metabolism is a fundamental indicator of nutrient and organic matter cycling and provides an integrative measure of stream structure and function (Izagirre *et al.*, 2008; Williamson *et al.*, 2008). Because carbon cycling drives other nutrient cycles and provides a food-web base via autotrophic production and processing of allochthonous materials, factors that control rates of stream metabolism will probably regulate other properties of these systems, including nutrient process rates and secondary production (Meyer *et al.*, 2007).

The ecological importance of stream metabolism has stimulated numerous empirical studies of its rates and controls, albeit mostly within a single stream or among a few streams within a single region. Key regulators include light availability (Dodds, Biggs & Lowe, 1999; Mulholland *et al.*, 2001; Roberts, Mulholland & Hill, 2007), nutrient concentration (Grimm & Fisher, 1986; Guasch, Martí & Sabater, 1995), organic

matter quantity and quality (Fisher & Likens, 1973; Webster & Meyer, 1997), and hydrology (Acuña, Giorgi & Muñoz, 2004; Roberts *et al.*, 2007). These proximal factors that affect rates of stream metabolism are, in turn, regulated by distal controls that integrate current and historical abiotic and biotic conditions as a function of climate, soil, vegetation and disturbance (Fig. 1).

Anthropogenic modifications of headwater streams and their riparian zones influence stream metabolism (e.g. Bunn, Davies & Mosisch, 1999; Young & Huryn, 1999; Houser, Mulholland & Maloney, 2005), which affects how nutrients are retained or transformed as the water moves downstream (e.g. Guasch *et al.*, 1995; Grimm *et al.*, 2005). Land use may modify proximal factors controlling stream metabolism through alteration of flow regimes (e.g. change in intensity or timing of flow; Keppler & Ziemer, 1990; Konrad, Booth & Burges, 2005) and increased nutrient, sediment, and pollutant runoff from agricultural and urban sources (e.g. fertilizer use and fossil fuel combustion; Johnson *et al.*, 1997; Jordan, Correll & Weller, 1997; Brett *et al.*, 2005). Despite the abundance of data describing proximal controls on stream metabolism, few studies have assessed how distal factors may interact with proximal factors to control

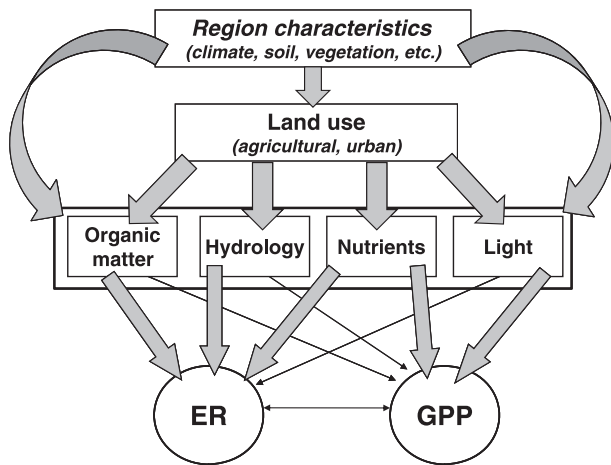

Fig. 1 Primary factors hypothesised to influence stream ecosystem respiration (ER) and gross primary production (GPP). Larger arrows indicate greater influence on rates of metabolism. Land use can influence all proximal factors and alter regional characteristics. Further, land use varies across regions (e.g. row-crop agriculture vs. irrigated pasture).

the rate of stream metabolism and how these factors vary in importance across diverse regions.

Across previous studies, proximal controlling factors are different for GPP and ER; with light and nutrients primary controls on GPP (Lamberti & Steinman, 1997; Mulholland *et al.*, 2001), and temperature, organic matter, hydrology, and, to a lesser extent, available nutrients, often driving rates of ER (Mulholland *et al.*, 2001; Sinsabaugh, 1997, 2002; Fig. 1). Land use can control stream metabolism because it influences these proximal controls, as can other distal controls such as climate and geology, via their effect on hydrology or riparian vegetation (e.g. Young & Huryn, 1999; McTammany *et al.*, 2003; Houser *et al.*, 2005). The interactions among these distal controls (i.e. contingency of land use effects on regional climate) remain largely undescribed. Multiple regional studies have shown distal effects, such as climate, soil, and vegetation, which regulate stream metabolism (Bott *et al.*, 1985; Hill *et al.*, 2000; Mulholland *et al.*, 2001). Distal regional factors could interact with changing land use to influence proximal controls on stream ecosystem metabolism, but the mechanisms remain unclear.

We measured metabolism in 70 streams in eight regions to estimate the relative importance of distal (regional climate, vegetation, soil, land use) and proximal (light, nutrients, organic matter) factors controlling stream ecosystem metabolism and to

assess the influence and interactions of land use on and with these controls. The primary goal of this effort was to improve our understanding of how human activities interact with environmental factors to affect ecosystem functioning across regions. We predicted that agricultural and urban activities would differentially affect stream metabolism across regions via changes in proximal factors. Differential effects were hypothesised to be dependent on distal factors of a given region. For example, changes in light because of clearing of riparian vegetation associated with agricultural and urban activities was hypothesised to affect GPP in forested regions more than in regions with little or low-lying riparian vegetation. Similarly, nutrient loading associated with anthropogenic activities may have a more pronounced effect on stream metabolism in low-nutrient streams relative to streams with inherently higher nutrient concentrations. Because of the interactions between proximal and distal controls on stream metabolism, we hypothesised variation in stream metabolism across land-use categories for a given region would be greatest in low-nutrient, forested ecosystems. We utilised multiple linear regressions to identify independent variables driving GPP and ER separately then applied these variables to confirmatory structural equation models to assess relative strengths of independent variables on overall stream metabolism.

Methods

Study sites

We measured stream metabolism in nine streams in each of eight regions across the United States and Puerto Rico in conjunction with the Lotic Intersite Nitrogen eXperiment II (LINX II; Table 1), although 2 of the 72 streams are not included in this analysis as explained below. In each region, three streams from three different land-use categories were selected based on the dominant land use adjacent to the study reach. Land-use categories were reference (REF, native vegetation with low human influence), agriculture (AGR, including rangeland, pasture, and row crops), and urban (URB, including low and high density residential, commercial, and golf courses). Land use was also quantified as a continuous variable at the catchment scale using the fraction of each category based on United States Geological Survey

Table 1 Region abbreviations, general location, and dominant reference vegetation

Region abbreviation	General site location*	Dominant reference vegetation	Dominant agriculture type	Dominant urban activity
KS	Central Kansas	Tall grass prairie	Row-crop, pasture	Residential
MA	Eastern Massachusetts	Deciduous forest	Pasture	Residential
MI	Southern Michigan	Deciduous forest	Row-crop	Suburban
NC	South-west North Carolina	Deciduous forest	Pasture	Residential
OR	Western Oregon	Wet coniferous-deciduous mixed forest	Grass seed/pasture	Residential/urban
PR	Eastern Puerto Rico	Tropical broadleaf forest	Row-crop, pasture	Residential
SW	Arizona and New Mexico	Desert shrub	Pasture	Residential/urban
WY	West-central Wyoming	Intermountain sagebrush steppe	Irrigated pasture	Residential

*Nine sites selected per region: three reference, three agricultural, three urban; See Data S1 for additional site information.

land-cover classifications (Mulholland *et al.*, 2008). Metabolism measurements were made in conjunction with ^{15}N -nitrate addition experiments during spring and summer in streams within the continental United States and during winter in Puerto Rican streams; analyses of relationships between metabolism and rates of nitrogen cycling are published elsewhere (see Mulholland *et al.*, 2008; Hall *et al.*, 2009; Mulholland *et al.*, 2009 for additional details and analyses of ^{15}N addition experiments).

Metabolism calculations

We calculated reach-scale metabolism using the standard technique of diel change in dissolved oxygen (O_2) in the open stream channel (e.g. Odum, 1956; Mulholland *et al.*, 2001). Corrections in the O_2 budget were made in streams with substantial groundwater input following the methods of Hall & Tank (2005). O_2 concentrations and temperature were logged at an upstream and downstream station at 5–15 min intervals for 24–48 h. All sites followed detailed and consistent protocols for calibrating oxygen sensors. Distance between upstream and downstream stations varied and depended on water velocity to achieve a 20–30 min travel time between stations (reach lengths ranged from 50 to 800 m). Reaeration rate, a measure of O_2 exchange between the stream and atmosphere and expressed as a rate constant (1 d^{-1}), was estimated with SF_6 or propane releases executed in conjunction with a conservative tracer release, with the latter also providing information on groundwater inputs and water travel time (Wanninkhof, Mulholland & Elwood, 1990; Marzolf, Mulholland & Steinman, 1994).

In 40 of the 72 streams, we were able to calculate metabolism using the 2-station method. In 30 streams, however, we were unable to calculate metabolism using the 2-station method for several reasons (e.g. sensor malfunction or large drift in sensor calibration at one of the two stations). Thus, metabolism estimates in those cases are made using a 1-station calculation, with the downstream sensor (end of the stream reach) being used for calculations in 20 of those streams and the upstream sensor used in 10 sites where downstream sensor data were either lost or of bad quality. Both the 1-station and 2-station estimation methods were randomly distributed among sites with differing land use (i.e. 2-station estimates are not biased by one land-use category or region). At one site (Southwest region, urban stream), we were unable to calculate GPP or ER because of the failure of both sensors. Additionally, in one Wyoming urban stream, we were unable to calculate ER because of particularly high groundwater input.

Metabolism using the 2-station method was calculated as:

$$g\text{O}_2\text{m}^{-2}\text{min}^{-1} = \left(\frac{C_t - C_0}{\Delta t} - k_{\text{O}_2} * D \right) * d$$

where: C = change in O_2 concentration from the upstream to downstream sensor in milligram per liter at time t and time 0 with t corresponding to water travel time between the two sensors (Δt , min); k_{O_2} is the oxygen reaeration coefficient (min^{-1}) corrected for stream temperature; D is the O_2 saturation deficit (i.e. saturation concentration minus average reach concentration) during the time interval for measured stream temperature and atmospheric pressure; d is mean

stream depth (m). We calculated stream depth (d) as follows:

$$d = \frac{Q}{Vw}$$

where: Q is stream discharge; w is average stream wetted width from measurements made every 1–2 m along the stream reach; and, V is average water velocity calculated from water travel time between stations. Metabolism using the 1-station method was calculated similarly to the 2-station calculation described above except changes in O_2 concentrations were calculated per measurement interval at a single measurement station:

$$gO_2 m^{-2} min^{-1} = \left(\frac{C_2 - C_1}{\Delta t_{meas}} - k_{O_2} * D \right) * d$$

where: C = change in O_2 concentration in milligram per liter at time 2 and time 1 at the same location (station). In this case, time is sensor measurement interval (Δt_{meas} , min).

Roberts *et al.* (2007) compared the 2-station and 1-station methods extensively in Walker Branch, Tennessee, and found the two methods gave similar results in streams with high reaeration rates. Streams with short water travel times through the study reach also should have comparable metabolism estimates between 1-station and 2-station calculations (Hall, Thomas & Gaiser, 2007). In our study, for sites where 2-station metabolism estimates were calculated, 1-station estimates were also calculated from both the upstream and downstream sensors. Both estimates were log-transformed then evaluated to assess consistency of methods (Fig. 2). Measures of ER using the 2-station estimation method were not different than those made with the 1-station estimation method (paired t -test, T -value = 0.17, P = >0.1, df = 37; Fig. 2a). Similarly, GPP estimates were comparable when calculated with the 2-station method relative to the 1-station method (paired t -test, T -value = <0.01, P > 0.1, df = 38; Fig. 2b). All analyses performed combined 1- and 2-station log-transformed estimates of GPP and ER.

Ancillary variables that might influence stream metabolism including riparian characteristics, transient storage, and organic matter biomass were measured in all streams using standard methods within 1 week of metabolism measurements (Table 2; Mulholland *et al.*, 2008; Hauer & Lamberti, 2005). For

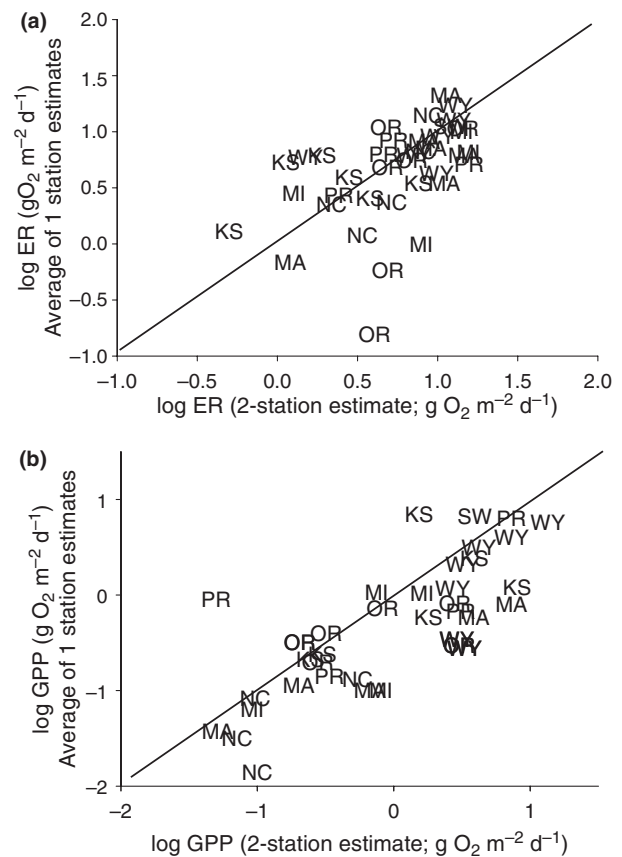

Fig. 2 Relationship between 2-station and 1-station estimates of (a) ecosystem respiration, ER and (b) gross primary production, GPP. Lines indicate 1 : 1 relationship. Region abbreviations given in Table 1.

all organic matter biomass estimates, stratified random sampling was conducted based on habitat surveys of each stream. Multiple samples of each organic matter type were randomly collected, and means of standing stock densities ($g m^{-2}$) for each organic matter type were weighted by the fractional contribution of that organic matter type to total stream area to calculate whole-stream standing stock. The number of samples per organic matter type was dependent on the relative abundance (e.g. three samples for organic matter types that comprised <10% of the stream reach, 6–8 samples for habitat types that comprised a higher percentage of the reach). Stream nutrient concentrations and photosynthetically active radiation (PAR) were measured concurrently with metabolism. PAR was measured at a location immediately adjacent to the stream channel and characteristic of light availability throughout the channel reach (i.e. shaded stream

Table 2 Summary of measured variables with method of sampling, abbreviation, reference, and statistical transformation used in data analysis

Independent variable	Abbreviation	Units	Sampling method	Reference	Statistical transformation
Region	RE	Categorical	NA	NA	NA
Velocity	VEL	m s^{-1}	Conservative solute transport	Stream Solute Workshop 1990,	Natural log
Disharge	Q	L s^{-1}	Change in conservative tracer from upstream to downstream	Webster & Ehrmann, 1996	Natural log
Stream temperature	TEMP	Degrees Celsius	Logging Hydrolab or YSI probes deployed in stream channel	Hauer & Lamberti, 2005	None
Channel width	WID	m	Line transect		Natural log
Channel depth	DEP	m	perpendicular to water flow with a minimum of 10		Natural log
Nitrate concentration	$\text{NO}_3^- \text{-N}$	$\mu\text{g NO}_3^- \text{-N L}^{-1}$	Collection of filtered water samples (GF/F nominal pore size <0.7 μm) and analysis for nutrient concentration by standard colorimetric or chromatography techniques	Ameel <i>et al.</i> , 1993; USEPA 1993	Natural log
Ammonium concentration	$\text{NH}_4^+ \text{-N}$	$\mu\text{g NH}_4^+ \text{-N L}^{-1}$			Natural log
Dissolved inorganic nitrogen concentration	DIN	$\mu\text{g N L}^{-1}$			Natural log
Dissolved organic nitrogen concentration	DON	$\mu\text{g N L}^{-1}$			Natural log
Soluble reactive phosphorus	SRP	$\mu\text{g P L}^{-1}$			Natural log
Dissolved organic carbon	DOC	mg C L^{-1}			Natural log
Dissolved oxygen	DO	$\text{mg O}_2 \text{ L}^{-1}$	Logging Hydrolab or YSI probes deployed in stream channel	Hauer & Hill, 1996	Natural log
Gross primary production	GPP	$\text{g O}_2 \text{ m}^{-2} \text{ d}^{-1}$	Diel changes in O_2 concentrations	Marzolf <i>et al.</i> , 1994; Hall & Tank, 2005	Natural log
Ecosystem respiration	ER	$\text{g O}_2 \text{ m}^{-2} \text{ d}^{-1}$	corrected for reaeration and groundwater input		Natural log
Heterotrophic respiration	CRhet	$\text{g O}_2 \text{ m}^{-2} \text{ d}^{-1}$			Natural log
Photosynthetically active radiation	PAR	$\text{mol quanta m}^{-2} \text{ d}^{-1}$	Logging light meter deployed adjacent to stream channel; average over 24 h	LiCor 190SA, LI-COR, Lincoln, NB, U.S.A.	Natural log
Coarse benthic organic matter	CBOM	g AFDM m^{-2}	Stratified random sampling and collection of known area of sample	Hauer & Lamberti, 2005	Natural log
Surface fine benthic organic matter	sFBOM	g AFDM m^{-2}	followed by drying and ashing of sample		Natural log
Deep fine benthic organic matter	dFBOM	g AFDM m^{-2}			Natural log
Autotrophic benthic organic matter	AUT	g AFDM m^{-2}			Natural log
Detrital benthic organic matter	dBOM	g AFDM m^{-2}			Natural log
Dispersion coefficient	D	$\text{m}^2 \text{ s}^{-1}$	Transient storage measurements	Bencala and Walters 1983, Runkel, 1998	Natural log
Cross sectional area of the channel	A	m^2	calculated from conservative tracer release and OTIS-P software		Natural log
Cross sectional area of the transient storage zone	A_s	m^2			Natural log
A_s/A	A_s/A	$\text{m}^2 \text{ m}^{-2}$			Natural log
R_h	R_h	s m^{-1}			Natural log
Fmed200	Fmed	Unitless			Natural log
Time spent in the storage zone	RET	s			Natural log

Table 2 (Continued)

Independent variable	Abbreviation	Units	Sampling method	Reference	Statistical transformation
Catchment area	Area	ha	Land cover analyses:	Helmer <i>et al.</i> , 2002	Natural log
Fraction of natural vegetation cover in the catchment	REF	Fraction	NLCD 2001 for all but PR, which is from NLCD 1991		Arcsine squareroot
Fraction of agricultural cover in the catchment	AGR	Fraction			Arcsine squareroot
Fraction of urban cover in the catchment	URB	Fraction			Arcsine squareroot
Substrata diameter	SubD	mm	Line transect perpendicular to water flow with a minimum of 10 measurements at each site using gravelometer	Hauer & Lamberti, 2005	Natural log

NA, not applicable; GPP, Gross primary production; ER, ecosystem respiration.

channels had PAR measurement recorded in similarly shaded locations next to the channel).

Statistics

All statistical analyses were performed on monotonic transformations of data to meet normality assumptions (Table 2). We selected predictor variables based on hypothesised relationships between them and ecosystem metabolism (Fig. 1). We estimated the association between proximal factors and GPP and ER using Pearson correlation analyses. We tested for differences in GPP or ER among regions and land-use categories using two-way analysis-of-variance (ANOVA) followed by Tukey's *post hoc* pairwise comparisons. To examine variation in metabolism within regions, we calculated coefficients of variation for each region (experimental unit) by dividing the standard deviation of GPP or ER by the mean of GPP or ER. To compare variation in metabolism across land-use categories within regions, we calculated coefficients of variation for land-use category ($n = 3$ for each land-use category) with region as the experimental unit ($n = 8$). Correlation and ANOVA statistics were performed using SAS statistical software (SAS Institute 1999).

Influence of distal factors (region, catchment land use) on GPP and ER and interaction between distal and proximal factors (light, nutrients, organic matter) were determined by developing predictive multiple linear regression models and Akaike's information

criterion (AIC) for statistical inference (Akaike, 1973; Burnham & Anderson, 2002). These multiple regression analyses allowed for inclusion of region as a predictive variable. The coefficients associated with the regional categorical values adjust the intercept of the regression model. Thus, analyses can indicate whether metabolism in one region is higher or lower than another region after accounting for other explanatory variables. Initially, multiple linear regression models predicting GPP or ER (without interaction or higher-order terms) were constructed using all potential predictors of these variables, including proximal and distal factors. To formulate models that balanced predictive ability and parsimony, we used stepwise procedure to add or remove predictor variables to produce models with the lowest scores of AIC_c (AIC corrected for small sample size) (Burnham & Anderson, 2002). To include a larger pool of explanatory variables, missing data were replaced in a small number of cases ($n = 5$) with the average value of the other two sites within the same land use and regional classification. While replacing missing data with means can distort estimates of variance, the distribution of missing data was sparse (≤ 3 of 72 sites for any one variable) and distributed among sites, land uses, and regions, suggesting this technique would have minimal influence on the model selection process (McCune & Grace, 2002). When missing data were not included in models, predictive variables were not significantly different. Analyses conducted using estimates for missing data identified additional

predictive variables. Selection of models was conducted with the statistical software R v.2.40 (R Development Core Team, 2006).

To assess proposed relationships among proximal and distal factors and GPP and ER simultaneously, we employed structural equation modelling (SEM) using observed variables and hypothesised causal pathways (Shipley, 2000; Grace, 2006). SEM was conducted on log-transformed data for 64 sites (eight sites were eliminated because of missing data), except that land use, quantified in the model as the sum of percentage urban and agricultural land in the catchment, and was arcsin transformed. Data were modelled using SPSS statistical software equipped with AMOS 17.0 (Amos v. 17.0; SPSS, Chicago, IL, U.S.A.). The original hypothesised model fit the structure of the data poorly, and additional suggested pathways were included incrementally to achieve the best model fit.

Although the purpose of SEM and multiple linear regression techniques are similar, each technique provides unique insight not afforded by the other. Multiple linear regression models allowed for inclusion of categorical regional variables and additional independent variables not afforded by SEM models for assessment of GPP and ER independently. However, multivariate regression compounds measurement error and increases Type I error. Since SEM paths are not additive, but are computed simultaneously, and because error terms are modelled in the analyses, problems with Type I and measurement error are decreased using this technique. We used multiple linear regression models as an exploratory tool whereas the SEM models were used as a confirmatory tool using *a priori* hypotheses established with exploratory models. SEM takes into account interactions, nonlinearities, correlated independent variables, and measurement error for a more robust analysis relative to multiple linear regressions. Advantages of SEM compared to multiple regression include more flexible assumptions (particularly when associated with multicollinearity), and the ability to test multiple dependent factors (i.e. GPP, ER), simultaneously.

Results

General patterns in stream metabolism

Across all streams, GPP ranged from 0.1 to 16.2 g O₂ m⁻² d⁻¹, and ER ranged from 0.4 to

23.1 g O₂ m⁻² d⁻¹ (Fig. 3). GPP differed significantly among regions (Table 3; Fig. 3a) and land-use category (Table 3; Fig. 3b), and there was no interaction between region and land-use category (ANOVA, $P = 0.32$). Regions with forested riparian vegetation (MA, NC, MI, OR, PR) had lower mean rates of GPP than regions with more open riparian vegetation (KS, WY, SW; Fig. 3a). Overall, reference streams had approximately 30% lower GPP than urban- or agriculturally influenced streams (Table 3; Fig. 3b).

Ecosystem respiration varied almost 100-fold across regions and among land-use categories (Fig. 3c,d). However, unlike GPP, there was a significant interaction between region and land-use category for ER (ANOVA interaction region*land-use category $P = 0.048$). This interaction suggests the response of ER to adjacent land-use practices depends on the regional context of the stream ecosystem. Only some regions had significant differences in ER between land-use categories. For example, the streams in Massachusetts ($P = 0.019$) and Kansas ($P = 0.032$) had higher ER in agricultural streams relative to urban streams, and the North Carolina streams had higher ER in reference relative to urban streams ($P = 0.041$).

All regions in this study, except Kansas, had negative rates of mean net ecosystem production (NEP; Fig. 3e), indicating net heterotrophic metabolism. Massachusetts, North Carolina, and Michigan had significantly lower NEP than other regions. Reference land use had significantly lower NEP than agricultural or urban land use across regions (Fig. 3f). There was no significant interaction between region and land-use category for NEP ($P = 0.37$). Across all sites, log ER co-varied positively with log GPP, but a number of streams had high rates of ER without correspondingly high rates of GPP (Fig. 4).

Factors controlling gross primary production and ecosystem respiration

Gross primary production increased with light availability (Fig. 5a) and total autotrophic biomass (Fig. 5b). Biomass of individual autotroph types (e.g. filamentous green algae, epilithon) did not correlate with any measure of GPP ($P > 0.15$). Although the correlation between GPP and light was strongest when light was measured as PAR, there was also a negative correlation with light measured as percentage

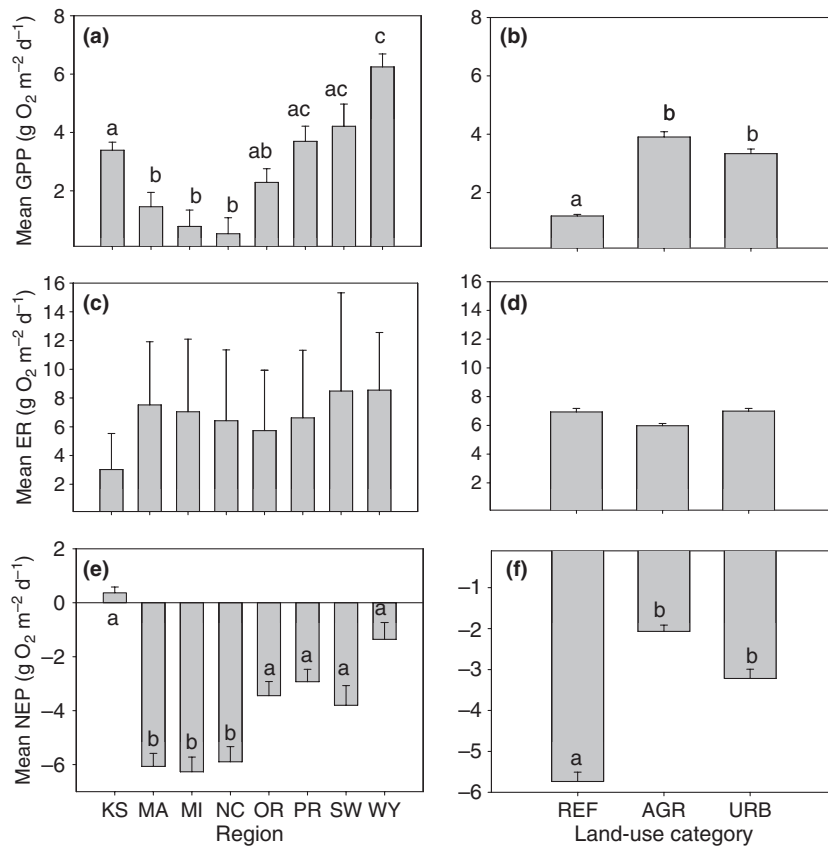

Fig. 3 Mean gross primary production (GPP) by (a) Region (arranged alphabetically) and (b) Land-use category; Mean ecosystem respiration (ER) by (c) Region and (d) Land-use category; Mean net ecosystem production (NEP) by (e) Region and (f) Land-use category. Region abbreviations given in Table 1. $n = 9$ for each region bar + SE. REF, reference; AG, agricultural; URB, urban. $n = 24$ for each land-use category bar + SE. Different letters indicate a significant difference within panels [Correction added on 2 June 2010, after first online publication: Figures 3, 4, 5 & 6 have been replaced. The text has changed from 'mg O₂' to 'g O₂'].

Table 3 Summary of multiple regression models for gross primary production (GPP) and ecosystem respiration (ER) selected based on AIC_c scores. Variables transformed and abbreviated according to Table 2

Rank	GPP Model Covariates	AIC _c	Δi AIC _c	Likelihood [L (g i x)]	wi	Adjusted R ²
1	RE, NH ₄ ⁺ -N, PAR, AUT, REF, URB	12.13	-2.06	2.80	2.80	0.67
2	RE, NH ₄ ⁺ -N, PAR, REF, URB	12.80	-1.38	1.99	1.99	0.65
3	RE, NH ₄ ⁺ -N, PAR, AUT, REF, URB, DON	14.13	-0.05	1.02	1.02	0.67
4	RE, NH ₄ ⁺ -N, PAR, REF, URB, DON	14.18	0.00	1.00	1.00	0.66
ER model covariates						
1	VEL, NO ₃ ⁻ -N, NH ₄ ⁺ -N, DOC, GPP, CBOM, sFBOM, REF, AGR, URB	-22.19	-0.17	1.09	1.09	0.28
2	VEL, TEMP, NO ₃ ⁻ -N, NH ₄ ⁺ -N, DOC, GPP, CBOM, sFBOM, REF, AGR	-22.05	-0.03	1.02	1.02	0.28
3	VEL, TEMP, NO ₃ ⁻ -N, NH ₄ ⁺ -N, DOC, GPP, CBOM, sFBOM, REF, AGR, URB	-22.04	-0.02	1.01	1.01	0.28
4	VEL, TEMP, NO ₃ ⁻ -N, NH ₄ ⁺ -N, DOC, GPP, CBOM, sFBOM, REF, AGR, URB	-22.02	0.00	1.00	1.00	0.29

canopy shade in riparian zone (*data not shown*; $r = 0.371$, $P = 0.03$). Within land-use categories, GPP was not related to PAR in urban or agricultural streams (Fig. 6). However, a significant linear relationship between GPP and PAR in reference streams across regions suggested that light limitation in reference streams drove the overall relationship; and therefore, light may not have been limiting

aquatic primary production in urban and agricultural streams.

The set of multiple regression models selected with AIC_c scores indicated that several additional variables influenced rates of GPP (Table 3). Specifically, the selected model included region, NH₄⁺-N concentrations, PAR, autotrophic biomass, and the fraction of the catchment in urban and reference land-use

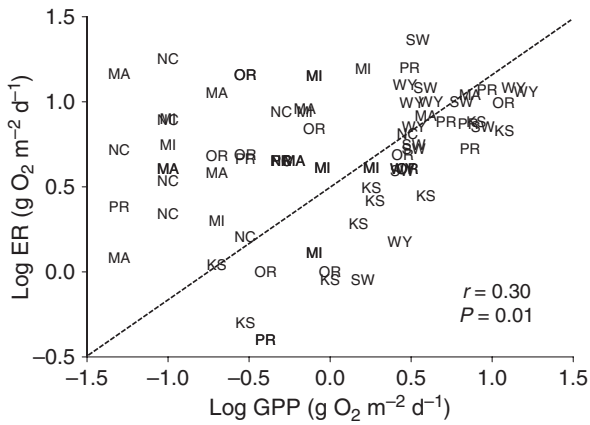

Fig. 4 Correlation between log-transformed gross primary production (GPP) and ecosystem respiration (ER). Dashed line indicates 1 : 1 relationship. Region abbreviations given in Table 1.

categories as explanatory variables. Variables in the selected multiple regression models were also significant in three alternative models with low AIC_c values (Table 3). Overall, higher GPP was associated with decreased reference vegetation or urban land use in the catchment (Table 4). The set of multiple linear regression models selected with AIC_c scores for ER included velocity, temperature, NO₃⁻-N, NH₄⁺-N, DOC, GPP, CBOM, surface FBOM, and the fraction of reference, agricultural and urban land use in the catchment (Tables 3 & 4).

Structural equation modelling identified significant causal relationships between stream variables and measured metabolism (Fig. 7). Our model of the controls on stream metabolism was a significant fit to the covariance matrix (χ^2 test $P = 0.161$, $df = 13$). Significant pathways included land-use effects on SRP, DIN, and GPP; PAR effects on GPP; GPP effects on autotrophic biomass, organic matter, and ER; and organic matter effects on ER. Land use did not affect PAR and DIN, and SRP concentrations did not significantly influence GPP or ER across all regions

and land-use categories. Land use had the greatest effect on DIN concentrations, but DIN concentrations did not significantly influence stream metabolism. Catchment land use also significantly influenced GPP, although this must have exerted its influence through a proximal variable not measured in this analysis. When land use was removed, model fit was not consistent with the data (i.e. predictive model did not reproduce the data). ER increased with organic matter which was negatively influenced by GPP. Overall, multiple regression models developed for GPP were stronger than those developed for ER, explaining 67% compared with 28% of the variation, respectively.

Multiple linear regression models selected according to AIC_c criteria contained similar explanatory variables to the SEM model although GPP and ER response to nutrient concentrations was inconsistent among models. Specifically, multiple linear regression models indicated NH₄⁺-N and NO₃⁻-N were important predictors of stream metabolism whereas the SEM model indicated DIN was not a significant proximal or distal influence. This was also true when DIN was modelled as NH₄⁺-N and NO₃⁻-N as individual variables in SEM. Separation of DIN into NH₄⁺-N and NO₃⁻-N in SEM yielded models that were inconsistent with the data, reducing explanatory power. Adjusted R^2 values of multiple regression models (mean $R^2 = 0.66$) for GPP were comparable to R^2 calculated for GPP in SEM models ($R^2 = 0.66$). However, adjusted R^2 for ER multiple regression models (mean = 0.28) were much lower than SEM values ($R^2 = 0.85$), indicating that the SEM model was better at explaining observed variance in ER.

Variation in metabolism

For streams grouped by region, the coefficient of variation (CV) in GPP ranged from 0.5 to 2.0 (Fig. 8a). In comparison, streams grouped by land-use category

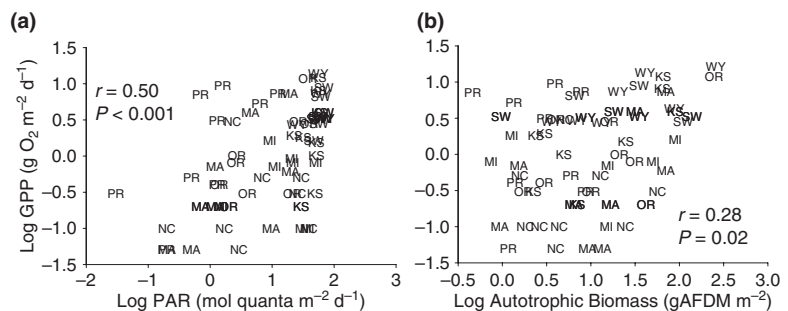

Fig. 5 Correlation between gross primary production and (a) photosynthetically active radiation (PAR) and (b) total autotrophic biomass. Region abbreviations given in Table 1.

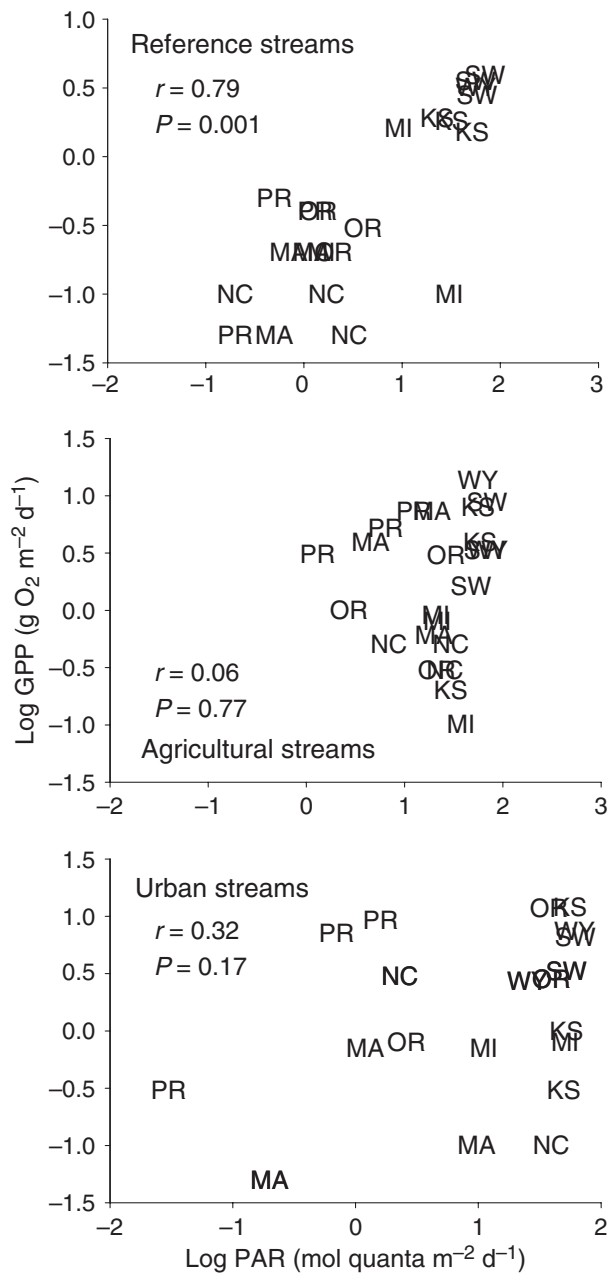

Fig. 6 Relationship between photosynthetically active radiation (PAR) and gross primary production (GPP) in streams influenced by different land-use categories. Region abbreviations given in Table 1.

yielded CVs ranging from 1.3 to 5.8 (Fig. 8b) indicating that within region variation metabolism is less than within land-use category. Reference streams had higher variation in GPP than agriculturally influenced or urban-influenced streams (ANOVA $P < 0.001$; Fig. 8b). Forested regions (MA, NC, MI, OR, PR) had lower CVs for GPP than open-canopy regions (WY,

Table 4 Gross primary production (GPP) and ecosystem respiration (ER) summaries for final models selected by stepwise AICc. Variables transformed and abbreviated according to Table 2

Gross primary production (GPP) model summary				
Variable	Estimate	SE	<i>t</i>	<i>P</i>
(Intercept)	0.77	1.07	0.72	0.47
REMA	-1.21	0.67	-1.80	0.08
REMI	-1.52	0.55	-2.75	0.01
RENC	-1.48	0.52	-2.83	0.01
REOR	0.06	0.51	0.13	0.90
REPR	0.78	0.64	1.22	0.23
RESW	0.89	0.47	1.88	0.07
REWY	0.95	0.47	2.01	0.05
NH4	0.32	0.11	2.91	0.01
PAR	0.33	0.10	3.11	0.00
AUT	0.14	0.08	1.80	0.08
REF	-2.91	0.72	-4.04	0.00
URB	-1.83	0.82	-2.25	0.03
Ecosystem respiration (ER) model summary				
(Intercept)	4.25	2.51	1.69	0.10
VEL	0.41	0.11	3.73	0.00
NO3	-0.12	0.05	-2.20	0.03
NH4	0.15	0.08	1.91	0.06
DOC	-0.16	0.13	-1.23	0.23
GPP	0.20	0.08	2.54	0.01
CBOM	0.17	0.07	2.35	0.02
sFBOM	0.75	0.33	2.29	0.03
REF	-3.88	2.47	-1.57	0.12
AGR	-3.02	2.15	-1.41	0.16
URB	-3.11	2.25	-1.38	0.17

SW, KS). It is probable that forested Michigan sites had higher variation in GPP because three of the nine study streams were measured in spring prior to complete leaf-out. Variability in regional ER ranged from 1.2 to 2.3. Variation in ER was greater than variation in GPP in all regions except the Southwest. There was no significant difference in variation of ER among land-use categories (ANOVA $P > 0.15$).

Discussion

Our data provide one of the most comprehensive analyses of stream metabolism currently available because they span diverse regions and land cover, and they incorporate assessment of distal (region, land use) and proximal (light, nutrients) factors potentially influencing GPP and ER. The stream metabolism rates in this study are within the range reported for many other single and multi-site studies (Minshall *et al.*, 1983;

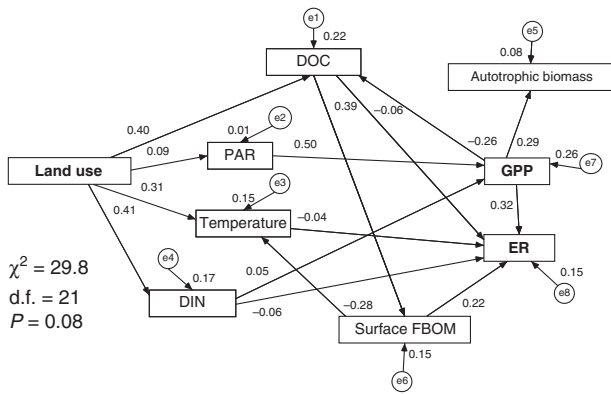

Fig. 7 Structural equation model to describe distal and proximal controls on stream gross primary production (GPP) and ecosystem respiration (ER). Boxes are variables in the model. Numbers are unstandardised path coefficients. Error variance was calculated for all variables and noted in paths. Solid lines indicate significant paths in the model ($P < 0.05$). Dashed lines denote hypothesised pathways that were not significant in the model ($P > 0.1$). Model fit statistics given at lower left. All variables were log-transformed except land use which is the sum of the fraction of urban and agricultural land use in the catchment and was arcsin transformed.

Lamberti & Steinman, 1997; Sinsabaugh, 1997). Further, observed rates of GPP and ER were within the same range as previous inter-regional analyses from LINX I experiments (Mulholland *et al.*, 2001). The similar range in metabolism rates is somewhat unexpected, given that this study incorporates a broader range of both land-use categories and regions than previous studies. It may be that metabolism, an integrative measure of ecosystem function, is more conservative across diverse stream types than are other variables.

Considering stream metabolism as an indicator of trophic state, our geographic range of reference sites provides a stronger assessment of data previously used to create designations of trophic state (Dodds, 2006; Table 5). More generalised frequency distributions than those created by Dodds (2006) are needed (Dodds & Cole, 2007), and our data help fill this void. Ecosystem respiration rates for reference sites in this study were similar to those reported by Dodds (2006) although our ER rates are somewhat less tightly constrained (the middle 1/3 of the distribution was approximately 4 times greater). We attribute the high variance in ER to greater difficulty in accurately and precisely measuring ER, compared to GPP, in streams (McCutchan, Lewis & Saunders, 1998).

These data also allow comparison of human-influenced streams with respect to both GPP and ER.

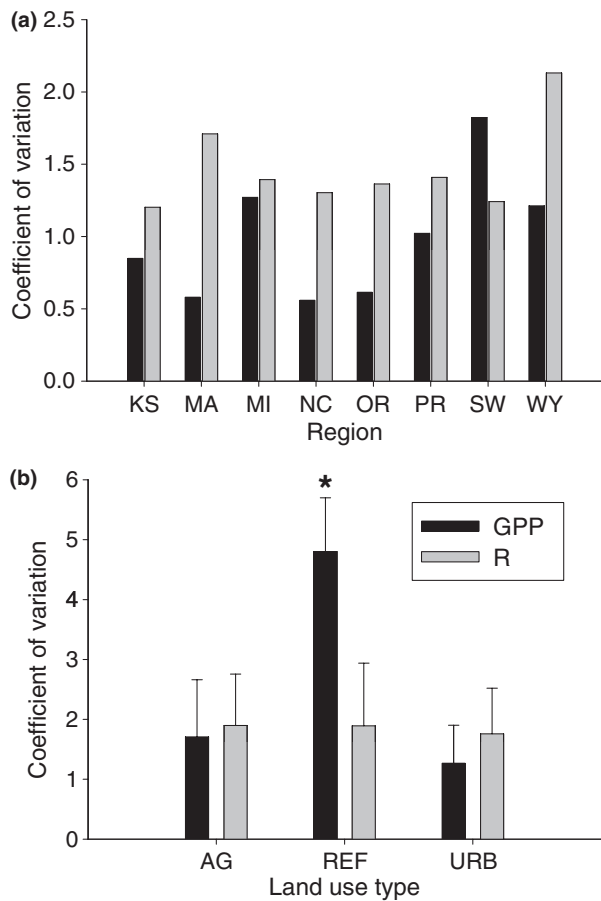

Fig. 8 Variation in gross primary productivity (GPP) and ecosystem respiration (ER) with (a) Region (arranged alphabetically), and (b) Land-use category. Variation calculated as coefficient of variation (standard deviation divided by the mean) of ecosystem rates. $n = 9$ for each region except WY ER $n = 8$. Region abbreviations given in Table 1. $n = 8$ for each land-use category. REF, reference; AG, agricultural; URB, urban. Significant differences denoted by * (ANOVA, $P < 0.001$).

Urban and agricultural streams had higher values for GPP (middle-third of the distribution and maximum), as would be expected with higher nutrients, increased light because of open canopy, or both. Neither urban nor agricultural streams differed substantially with respect to ER, suggesting that land use more strongly influences autotrophic production than organic matter inputs (amount and type) in our study regions.

Proximal factors influencing gross primary production and ecosystem respiration

First-order controls on stream metabolism identified in this study were consistent with previous studies (Lamberti & Steinman, 1997; Mulholland *et al.*, 2001)

	Distribution	Stream metabolism (g O ₂ m ⁻² d ⁻¹)		
		Gross primary production	Ecosystem respiration	Net ecosystem production
Reference	Upper one-third	1.8	9.8	-1.8
	Lower one-third	0.2	3.1	-7.8
	Minimum	0.1	0.4	-19.6
	Maximum	3.9	23.1	0.0
Agricultural	Upper one-third	3.9	7.6	0.0
	Lower one-third	0.8	4.1	-3.8
	Minimum	0.1	0.9	-12.6
	Maximum	16.2	15.7	4.8
Urban	Upper one-third	3.3	8.7	-0.3
	Lower one-third	0.7	4.9	-5.8
	Minimum	0.1	0.5	-17.8
	Maximum	11.9	17.9	7.3
Dodds, 2006	Upper one-third	1.8	8.3	-4.2
	Lower one-third	0.4	6.7	-6.7
	Minimum	0.1	2.4	-29.0
	Maximum	15.0	29.0	6.7

Table 5 Distributions of whole-stream metabolism rates by land-use category. Rate distributions by trophic status compiled by Dodds (2006) are included for comparison

although this analysis provided several novel contributions regarding the relative strength of these proximal controls across geographic regions. For example, even though type and abundance of autotrophic organisms varied widely among our study sites, total autotrophic biomass was correlated with GPP (g AFDM m⁻²; Fig. 5b), and total autotrophic biomass was a significant predictive variable in multiple regression and structural equation models. Interestingly, autotrophs in Puerto Rican streams were dominated by epilithon, and biomass (as indicated by chlorophyll) was low relative to other streams, yet Puerto Rican streams had high GPP relative to available PAR (Fig. 6a). Thus, epilithic autotrophs in these streams appear to have higher photosynthetic efficiencies (Minshall, 1978; Hill, Ryon & Schilling, 1995), and available PAR has less of an effect on ecosystem production.

Multiple regression models indicated NH₄⁺-N was a proximal factor influencing GPP, and both NH₄⁺-N and NO₃⁻-N were significant proximal controls identified in ER multiple regression models. However, in SEM models, DIN (sum of NH₄⁺-N and NO₃⁻-N) was not a significant proximal influence on GPP or ER but was necessary for a model fit consistent with the data (Fig. 8). Although land use can greatly influence DIN concentrations (Mulholland *et al.*, 2008), distal controls (e.g. soil, vegetation, climate) associated with individual regions probably determine the role of DIN in controlling stream metabolism.

Contrary to previous inter-regional comparisons of stream metabolism (Lamberti & Steinman, 1997; Mulholland *et al.*, 2001), we found no relationship between SRP concentration and GPP. Our study incorporated a wider array of stream types from multiple land-use categories than either of the other two studies. The range in SRP concentrations was considerably greater in the current study (0.17–310.5 µg SRP L⁻¹ in this study, 1.8–13.2 µg SRP L⁻¹ in Mulholland *et al.*, 2001), and dissolved inorganic phosphorus may only be a proximal factor controlling GPP at low concentrations, whereas other factors may exert stronger control when phosphorus concentrations are higher. However, the relationship between SRP and GPP was not significant even when only reference sites with lower SRP concentrations were analysed ($P = 0.70$, *data not shown*). Thus, our data may indicate that *P* is not limiting to GPP in most of the study streams and that we selected predominantly N-limited streams (Johnson, Tank & Dodds, 2009). Alternatively, *P* limitation may not emerge as a key factor because it is masked by other factors (e.g. PAR) that better explain variation across the wide range of systems considered. *P* availability also may vary temporally, and our single measurement at each stream may have missed preceding periods when it was low. A similar argument may explain why DIN fails to directly link to GPP in the SEM model; single concentration values from a stream may fail to adequately characterise nutrient availability.

Distal factors influencing gross primary production and ecosystem respiration

In comparison with reference streams, urban and agricultural activity increased GPP in most regions (Fig. 3) including 11 individual streams with $GPP : ER > 1$. This trend suggests that energy sources become increasingly autochthonous in streams with increased urban and agricultural activity in the catchment. Across all sites, GPP was only light limited in reference streams (Fig. 6a) and land-use change associated with agricultural and urban activities probably relieved light limitation in forested regions (MI, NC, OR). Alternatively, agricultural and urban activities may be disconnecting streams from their riparian zones and catchments, ultimately changing the primary energy source (e.g. through modifications such as concrete-lined channels, dredging, and compaction of substrata).

Although we expected land use to significantly influence GPP, we did not expect urban and agricultural activities to yield a similar ecosystem response given differences in pressures applied by these two activities. Across regions, urban and agriculture activities probably influence proximal controls on metabolism similarly (changing light availability, hydrology) resulting in comparable ecosystem responses. Regional agricultural activity (e.g. either row-crop or pasture) can alter proximal factors in a manner that is distinct from regional urban activity (e.g. suburban or urban development) yielding significant differences in ecosystem metabolism among land-use categories within a region. However, this distal effect is muted across regions with variable characteristics.

The study region was a statistically significant variable for models of GPP but not ER (Tables 3 & 4). Thus, distal factors such as climate and catchment vegetation may be as important as proximal factors in driving variation in primary productivity of streams across regions. Further, GPP increased with decreasing fraction of reference land cover, and increasing fraction of agricultural and urban land use in the catchment, probably as a result of the influence of human activities in these land-use categories on proximal factors such as light, nutrients, and organic matter. In a region with little natural riparian vegetation or inherently high nutrient concentrations, changes in these proximal factors

would be expected to have minimal effects on GPP. However, no interaction between region and land use was observed indicating that in regions with little riparian vegetation, anthropogenic nutrient enrichment may be alleviated. In contrast, the significant interaction between region and land use effects on ER (Table 3, Fig. 4) suggests that some regional characteristics controlling ER may be influenced by land use.

For our SEM model, land use was quantified as the sum of the fraction of urban and agricultural land use in the catchment and this distal variable significantly influenced GPP but not ER. Thus, agricultural and urban activities evidently influence GPP through mechanisms not identified in this study. For example, changing land use may introduce trace organic contaminants (e.g. pesticides, pharmaceuticals) that influence rates of production through toxicity or as potential carbon sources stimulating heterotrophic activity. Alternatively, reduced stability of benthic substrata may have inhibited algal attachment in agriculturally influenced streams.

Interactions between proximal and distal factors influencing ecosystem metabolism

Comparing models developed using SEM with multiple linear regression models allows for assessment of interactions between proximal and distal controls on stream metabolism. Interactions between proximal and distal controls on stream metabolism were most predominant with regards to the effects of light on GPP and the effects of hydrology on ER. Urbanisation and agriculture tend to reduce light limitation through clearing of riparian vegetation thereby increasing GPP (Young & Huryn, 1999). However, in some regions, particularly those with less compacted soils, agricultural and urban activities may increase light limitation by increasing suspended sediments (Allan, Erickson & Fay, 1997). Similarly, the lack of a relationship between transient storage parameters and ER in this study may be because of the inclusion of these land-use categories across geographical regions. Urban and agricultural activities may decrease transient storage and hydrologic variability through dredging, channelisation, and other activities (Gooseff, Hall & Tank, 2007). Alternatively, the lack of significance of transient storage metrics may indicate ER is primarily controlled by surface organic matter

with little hyporheic interaction (Fellows, Valett & Dahm, 2001). Overall, multiple regression models developed for GPP were stronger than those developed for ER, explaining 67% compared with 28% of the variation, respectively.

Land use reduced regional variation in stream GPP (Fig. 8). Changes in stream structure associated with agricultural and urban activities were similar across most regions (e.g. stream channelisation, removal of riparian vegetation, etc.). These changes modify regional characteristics (canopy cover, catchment vegetation, hydrology, etc.) that alter ecosystem function via proximal factors (Fig. 1). This homogenisation of ecosystem structure and function has been suggested as a general outcome of urbanisation (Grimm *et al.*, 2008). Anthropogenic simplification of habitats has been and continues to be a global concern (e.g. Cardinale *et al.*, 2001), but the loss of regional variation in ecosystem structure and function in conjunction with this habitat simplification has only been minimally addressed (e.g. Poff *et al.*, 1997; Rahel, 2000). Here, we show that land use can alter abiotic properties, thus overriding regional constraints on stream metabolism. If geographical differences in rates of ecosystem activity are minimised because of land use, differences in stream ecosystem structure among regions may also be threatened. For example, species diversity may decline in conjunction with species having a higher affinity for characteristics associated with a given region. Further, spread of invasive species may be fostered with increased similarity among ecosystems across regions. Future studies and management strategies should strive to assess, identify, and preserve unique regional properties within stream ecosystems to minimise the influence of land-use change on ecosystem structure and function.

Acknowledgments

This work was supported by a U.S. National Science Foundation grant (DEB-0111410) to PJM, University of Tennessee and additional NSF LTER support at many of the sites. We thank all LINX II site crews for research assistance, private and public landowners and community participants for access to sites and site information, D Gudder and two anonymous reviewers for comments on the manuscript, and BJ Roberts and RJ Bernot for helpful discussions.

References

- Acuña V., Giorgi A. & Muñoz I. (2004) Flow extremes and benthic organic matter shape the metabolism of a headwater Mediterranean stream. *Freshwater Biology*, **49**, 960–971.
- Akaike H. (1973) Information theory and an extension of the maximum likelihood principle. In: *Second International Symposium on Information Theory* (Eds B.N. Petrov & F. Csaki), pp. 267–281. Akademiai Kiado, Budapest.
- Allan D.J., Erickson D.L. & Fay J. (1997) The influence of catchment land use on stream integrity across multiple spatial scales. *Freshwater Biology*, **37**, 149–161.
- Ameel J.J., Axler R.P. & Owen C.J. (1993) Persulfate digestion for determination of total nitrogen and phosphorus in low nutrient waters. *American Environmental Laboratory*, **10/93**, 7–11.
- Bencala K.E. & Walters R.A. (1983) Simulation of solute transport in a mountain pool-and-riffle stream: A transient storage model. *Water Resources Research*, **19**, 718–724.
- Bott T.L., Brock J.T., Dunn C.S., Naiman R.J., Ovink R.W. & Petersen R.C. (1985) Benthic community metabolism in four temperate stream systems; -an interregion comparison and evaluations of the river continuum concept. *Hydrobiologia*, **123**, 3–45.
- Brett M.T., Arhonditsis G.B., Mueller S.E., Hartley D.M., Frodge J.D. & Funke D.E. (2005) Non-point-source impacts on stream nutrient concentrations along a forest to urban gradient. *Environmental Management*, **35**, 330–342.
- Bunn S.E., Davies P.M. & Mosisch T.D. (1999) Ecosystem measures of river health and their response to riparian and catchment degradation. *Freshwater Biology*, **41**, 333–345.
- Burnham K.P. & Anderson D.R. (2002) *Model Selection and Multimodel Inference: A Practical Information-Theoretic Approach*, 2nd edn. Springer-Verlag, New York.
- Cardinale B.J., Palmer M.A., Swan C.M., Brooks S. & Poff N.L. (2001) The influence of substrate heterogeneity on biofilm metabolism in a stream ecosystem. *Ecology*, **83**, 412–422.
- Dodds W.K. (2006) Eutrophication and trophic state in rivers and streams. *Limnology and Oceanography*, **51**, 671–680.
- Dodds W.K. & Cole J.J. (2007) Expanding the concept of trophic state in aquatic ecosystems: it's not just the autotrophs. *Aquatic Sciences*, **69**, 427–439.
- Dodds W.K., Biggs B.J.F. & Lowe R.L. (1999) Photosynthesis-irradiance patterns in benthic microalgae: variations as a function of assemblage thickness and community structure. *Journal of Phycology*, **35**, 42–53.

- Fellows C.S., Valett H.M. & Dahm C.N. (2001) Whole-stream metabolism in two montane streams: contribution of the hyporheic zone. *Limnology and Oceanography*, **46**, 523–531.
- Fisher S.G. & Likens G.E. (1973) Energy flow in Bear Brook, New Hampshire: An integrative approach to stream ecosystem metabolism. *Ecological Monographs*, **43**, 421–439.
- Gooseff M.N., Hall R.O. & Tank J.L. (2007) Relating transient storage to channel complexity in streams of varying land use in Jackson Hole, Wyoming. *Water Resources Research*, **43**, W01417, doi: 10.1029/2005WR004626.
- Grace J.B. (2006) *Structural Equation Modeling and Natural Systems*. Cambridge University Press, Cambridge, UK.
- Grimm N.B. & Fisher S.G. (1986) Nitrogen limitation in a Sonoran Desert stream. *Journal of the North American Benthological Society* **5**, 2–15.
- Grimm N.B., Sheibley R.W., Crenshaw C., Dahm C.N., Roach W.J. & Zeglin L. (2005) N retention and transformation in urban streams. *Journal of the North American Benthological Society* **24**, 626–642.
- Grimm N.B., Foster D., Groffman P., Grove J.M., Hopkinson C.S., Nadelhoffer K., Peters D. & Pataki D.E. (2008) The changing landscape: ecosystem responses to urbanization and pollution across climatic and societal gradients. *Frontiers in Ecology and the Environment* **6**, 264–272.
- Guasch H., Martí E. & Sabater S. (1995) Nutrient enrichment effects on biofilm metabolism in a Mediterranean stream. *Freshwater Biology*, **33**, 373–383.
- Hall R.O. & Tank J.L. (2005) Correcting whole-stream estimates of metabolism for groundwater input. *Limnology and Oceanography: Methods*, **3**, 222–229.
- Hall R.O., Thomas S. & Gaiser E.E. (2007) Measuring freshwater primary production and respiration. In: *Principles and Standards for Measuring Primary Production* (Eds T.J. Fahey & A.K. Knapp), pp. 175–203. Oxford University Press, Oxford.
- Hall R.O., Tank J.L., Sobota D.J. *et al.* (2009) Nitrate removal in stream ecosystem measured by ¹⁵N addition experiments: total uptake. *Limnology and Oceanography*, **54**, 653–665.
- Hauer F.R. & Hill W.R. (1996) Temperature, light, and oxygen. In: *Methods in Stream Ecology* (Eds F.R. Hauer & G.A. Lamberti), pp. 93–106. Academic Press, San Diego, CA.
- Hauer F.R. & Lamberti G.A. (2005) *Methods in Stream Ecology*. Academic Press, San Diego, CA, USA.
- Helmer E.H., Ramos O., López T., del M., Quiñones M. & Diaz W. (2002) Mapping the forest type and land cover of Puerto Rico, a component of the Caribbean biodiversity hotspot. *Caribbean Journal of Science*, **38**, 165–183.
- Hill W.R., Ryon M.G. & Schilling E.M. (1995) Light limitation in a stream ecosystem: responses by primary producers and consumers. *Ecology* **76**, 1297–1309.
- Hill B.H., Hall R.K., Husby P., Herlihy A.T. & Dunne M. (2000) Inter-regional comparisons of sediment microbial respiration in streams. *Freshwater Biology*, **44**, 213–221.
- Houser J.N., Mulholland P.J. & Maloney K.O. (2005) Catchment disturbance and stream metabolism: patterns in ecosystem respiration and gross primary production along a gradient of upland soil and vegetation disturbance. *Journal of the North American Benthological Society*, **24**, 538–541.
- Izagirre O., Agirre U., Bermejo M., Pozo J. & Elosegi A. (2008) Environmental controls of whole-stream metabolism identified from continuous monitoring of Basque streams. *Journal of the North American Benthological Society*, **27**, 252–268.
- Johnson L.B., Richards C., Host G.E. & Arthur J.W. (1997) Landscape influences on water chemistry in Midwestern stream ecosystems. *Freshwater Biology*, **37**, 193–208.
- Johnson L.T., Tank J.L. & Dodds W.K. (2009) The influence of land use on stream biofilm nutrient limitation across eight North American ecoregions. *Canadian Journal of Fisheries and Aquatic Sciences*, **66**, 1081–1094.
- Jordan T.E., Correll D.L. & Weller D.E. (1997) Relating nutrient discharges from watersheds to land use and streamflow variability. *Water Resources Research*, **33**, 2579–2590.
- Kepler E.T. & Ziemer R.R. (1990) Logging effects on streamflow: water yield and summer low flows at Caspar Creek in Northwestern California. *Water Resources Research*, **26**, 1669–1679.
- Konrad C.P., Booth D.B. & Burges S.J. (2005) Effects of urban development in the Puget Lowland, Washington, on interannual streamflow patterns: consequences for channel form and streambed disturbance. *Water Resources Research*, **41**, 1–15.
- Lamberti G.A. & Steinman A.D. (1997) A comparison of primary production in stream ecosystems. *Journal of the North American Benthological Society*, **16**, 95–104.
- Marzolf E.R., Mulholland P.J. & Steinman A.D. (1994) Improvements to the diurnal upstream-downstream dissolved-oxygen change technique for determining whole-stream metabolism in small streams. *Canadian Journal of Fisheries and Aquatic Sciences*, **51**, 1591–1599.
- McCune B. & Grace J.B. (2002) *Analysis of Ecological Communities*. MjM Software Design, Gleneden Beach, Oregon, USA.

- McCutchan J.H., Lewis W.M. & Saunders J.F. (1998) Uncertainty in the estimation of stream metabolism from open-channel oxygen concentrations. *Journal of the North American Benthological Society*, **17**, 155–164.
- McTammany M.E., Webster J.R., Benfield E.R. & Neatrour M.A. (2003) Longitudinal patterns of metabolism in a southern Appalachian river. *Journal of the North American Benthological Society*, **22**, 359–370.
- Meyer J.L., Strayer D.L., Wallace B., Eggert S.L., Helfman G.S. & Leonard N.E. (2007) The contribution of headwater streams to biodiversity in river networks. *Journal of the American Water Resources Association*, **43**, 86–103.
- Minshall G.W. (1978) Autotrophy in stream ecosystems. *BioScience*, **28**, 767–771.
- Minshall G.W., Petersen R.C., Cummins K.W., Bott T.L., Sedell J.R., Cushing C.E. & Vannote R.L. (1983) Inter-region comparison of stream ecosystem dynamics. *Ecological Monographs*, **53**, 1–25.
- Mulholland P.J., Fellows C.S., Tank J.L. et al. (2001) Inter-region comparison of factors controlling stream metabolism. *Freshwater Biology*, **46**, 1503–1517.
- Mulholland P.J., Helton A.M., Poole G.C. et al. (2008) Stream denitrification across biomes and its response to anthropogenic nitrate loading. *Nature*, **452**, 202–205.
- Mulholland P.J., Hall R.O., Sobota D.J. et al. (2009) Nitrate removal in stream ecosystems measured by ¹⁵N addition experiments: denitrification. *Limnology and Oceanography*, **54**, 666–680.
- Odum H.T. (1956) Primary production in flowing waters. *Limnology and Oceanography*, **1**, 102–117.
- Poff N.L., Allen J.D., Bain M.B., Karr J.R., Prestegard K.L., Richter B.D., Sparks R.E. & Stromberg J.C. (1997) The natural flow regime. *BioScience*, **47**, 769–784.
- R Development Core Team (2006) R: a language and environment for statistical computing. *R Foundation for Statistical Computing*. Vienna, Austria. ISBN 3-900051-07-0, URL <http://www.R-project.org>.
- Rahel F.J. (2000) Homogenization of fish faunas across the United States. *Science*, **288**, 854–856.
- Roberts B.J., Mulholland P.J. & Hill W.R. (2007) Multiple scales of temporal variability in ecosystem metabolism rates: results from 2 years of continuous monitoring in a forested headwater stream. *Ecosystems*, **10**, 588–606.
- Runkel R.L. (1998) *One-dimensional transport with inflow and storage (OTIS): A solute transport model for streams and rivers*. US Geological Survey Water-Resources Investigation Report 98-4018. US Geological Survey, Denver, CO. Available at: <http://co.water.usgs.gov/otis>.
- SAS Institute (1999) SAS/STAT User's Guide, 6.04. SAS Institute, Cary, North Carolina, USA.
- Shipley B. (2000) *Cause and Correlation in Biology: A User's Guide to Path Analysis, Structural Equation, and Causal Inference*. Cambridge University Press, Cambridge, UK.
- Sinsabaugh R.L. (1997) Large-scale trends for stream benthic respiration. *Journal of the North American Benthological Society*, **16**, 119–122.
- Sinsabaugh R.L. (2002) Sediment microbial respiration in a synoptic survey of mid-Atlantic region streams. *Freshwater Biology*, **39**, 493–501.
- Stream Solute Workshop (1990) Solute dynamics in streams. *Journal of the North American Benthological Society*, **9**, 95–119.
- USEPA (1993) *Method 300.0, Test Method for the Determination of Inorganic Anions in Water by Ion Chromatography*. Environmental Monitoring Systems Laboratory, USEPA ORD, Cincinnati, OH.
- Wanninkhof R., Mulholland P.J. & Elwood J.W. (1990) Gas-exchange rates for a 1st-order stream determined with deliberate and natural tracers. *Water Resources Research*, **26**, 1621–1630.
- Webster J.R. & Ehrmann T.P. (1996) Solute dynamics. In: *Methods in Stream Ecology* (Eds F.R. Hauer & G.A. Lamberti), pp. 145–160. Academic Press, San Diego, CA, USA.
- Webster J.R. & Meyer J.L. (1997) Organic matter budgets for streams: a synthesis. *Journal of the North American Benthological Society*, **16**, 141–161.
- Williamson C.E., Dodds W., Kratz T.K. & Palmer M. (2008) Lakes and streams as sentinels of environmental change in terrestrial and atmospheric processes. *Frontiers in Ecology and the Environment*, **6**, 247–254.
- Young R.G. & Huryn A.D. (1999) Effects of land use on stream metabolism and organic matter turnover. *Ecological Applications*, **9**, 1359–1376.

Supporting Information

Additional Supporting Information may be found in the online version of this article:

Data S1. Summary of stream sites and metabolism rates by region.

As a service to our authors and readers, this journal provides supporting information supplied by authors. Such materials are peer-reviewed and may be reorganized for online delivery, but are not copy-edited or typeset. Technical support issues arising from supporting information (other than missing files) should be addressed to the authors.

(Manuscript accepted 14 February 2010)